



ORION

2 / 4 / 8 Zone Fire Alarm Control Panel

INSTALLATION, OPERATION & MAINTENANCE MANUAL

GENERAL DESCRIPTION

The ORION is a 2, 4 and 8 Zone microprocessor controlled conventional Fire Alarm Control Panel with all the functions necessary to control small and medium size fire detection installations. Advanced configuration solutions include the following: programmable delay timer, zones coincidence, one man test and non-latching zones. Finally all inputs are fully monitored for both Fire, Activation and Fault Conditions.

EN54 INFORMATION

In accordance with EN54-2 clause 13.7, the maximum number of sensors and/or manual call points in this panel, will not exceed 512 units. The Fire Detection Control Panel complies with the requirements of EN54-2 and EN54-4. In addition to the requirements of the above mentioned standard, the unit conforms to the following optional functions:

EN54-2 Clause 7.11 Controls Delays for activation of outputs

EN54-2 Clause 8.3 Fault signals from points

MAIN FEATURES

- 2, 4 and 8 Zone non-expandable control panels
- Up to 32 conventional devices (smoke and/or heat detectors and call-points) per zone
- Active End of Line for Zone wiring monitoring (10uF/50V bipolar capacitor)
- Programmable non-latching zones (selectable for each zone)
- Programmable delay timer for sounder activation (maximum of 8 minutes)
- Day/Night function
- Delayed operation (selectable for each zone)
- Zone Coincidence programmable for adjacent zones
- Two Access Levels (selectable by fixed code entry)
- One man test capability
- Supervised auxiliary 24-volt supply output
- 2 Supervised/monitored sounder circuits
- 3 Remote Inputs (Class Change, Remote Reset and Day/Night Operation)
- 1 Remote Output indicating Zone disable
- Site memory integrity monitoring every 600 seconds
- 2 Relay outputs for fire and fault status indication (Unmonitored)
- Dedicated repeater panel and analogue loop interface
- Additional output via MPX-REL & MPX-SNDR modules
- EN54-2 and EN54-4 compliant.



OPTIONAL

- ORION MINI REP V2 is a repeater to be used with our standard data loop interfaces, RS232, RS485, Fibre Optics.Á
- ADLI is an analogue interface card available to interface ORION panel with our range of addressable panels, JUNO NET and JUNIOR.
- MPX REL DG is a module with 8 additional relays.
- MPX SNDR DG is a module with 8 additional sounders.

IMPORTANT SAFETY NOTES

- This equipment must only be installed and maintained by a suitably qualified and technically competent person.
- This equipment must have an Earth Connection.
- A basic knowledge and training in the installation of Fire Detection systems is assumed.
- The Fire Detection system should be designed by a suitably qualified person with reference to the Local Regulations and Guidance from the fire Officer where applicable.

MECHANICAL DATA

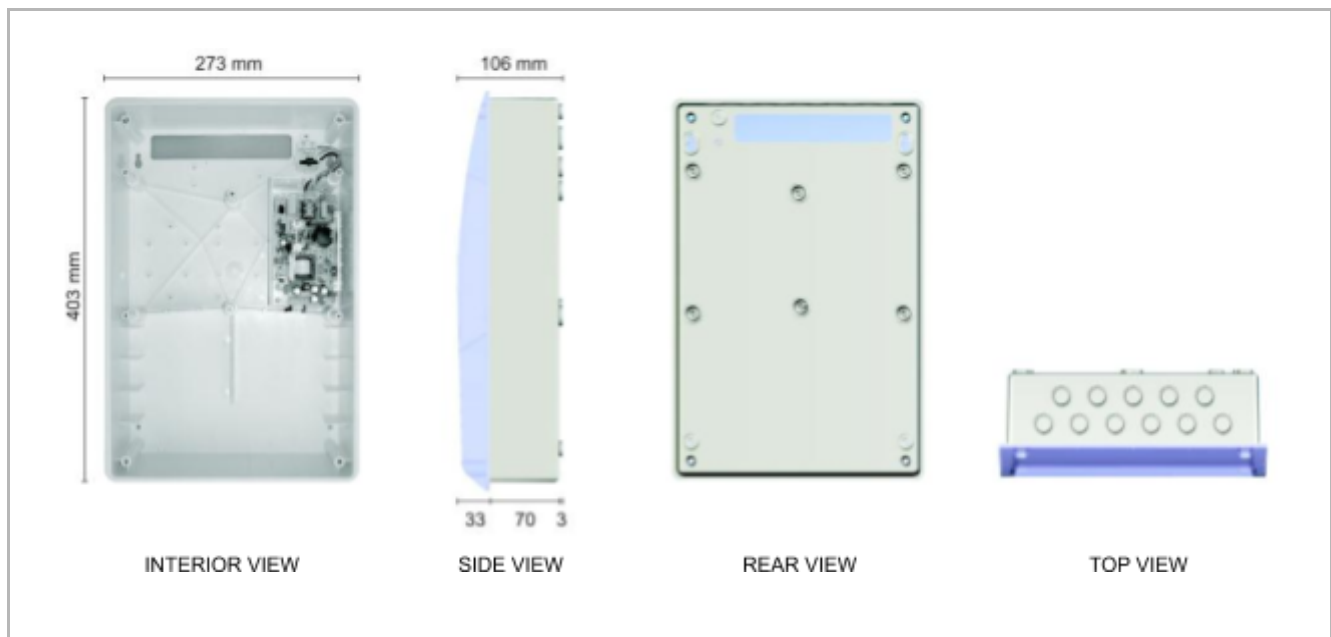

CABLE TYPES

System wiring should be installed in accordance with National Standards and wiring regulations.

To protect against electrical interference, we recommend the use of screened cables throughout the system. Separate cables should be used for sounder and detection circuits, the use of multi-core cables to carry sounder circuits and detector circuits is not recommended. The cable screen termination should only be connected to panel Earth points. The maximum cross section of cables to use is 2.5mm², otherwise terminals in the control panel could be damaged.

Mains wiring should be 3 core 1mm² to 2.5mm² fed from an isolating circuit breaker of 6A. This should be secure from unauthorized operation and be marked "Fire Alarm Do Not Switch Off". The mains supply must be exclusive to the fire panel.



CONNECTING THE PANEL

Before connecting zones or sounder cables, power up the control panel with the Active EOL connected to the zone inputs and the EOL resistors for the sounder/output lines connected. Then connect mains and battery power; there should be no fault indications. The mains supply should be routed away from the other cables and enter the control panel adjacent to the mains terminal block.

Depending on panel load and standby requirements, two 12-volt VLRA batteries of capacity up to 7Ah may be fitted in the housing. The batteries should be wired in series (24V) using the supplied link. Take care not to short circuit the battery terminals.

Check zones, remote input and outputs wiring for continuity. Short or open circuit indications must be rectified before connecting to the control panel. All cable testing must be carried out with a Multimeter... **NEVER use a Megger when devices are connected.**

Transfer EOL components to the last device on detection zones and sounder/output circuits and connect the cables to their respective terminals in the control panel. Please refer to the info available in next page.

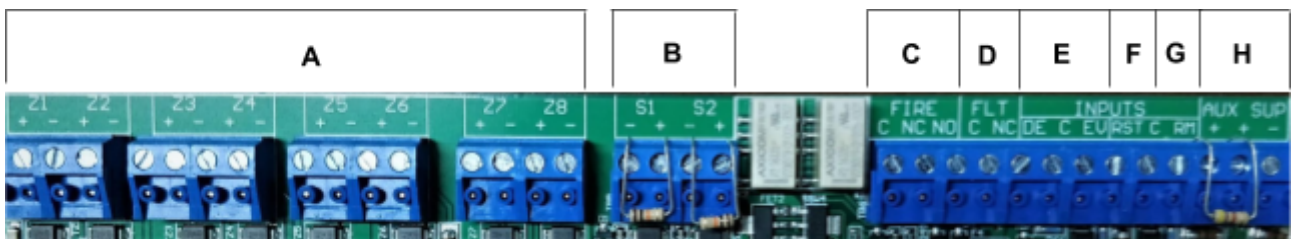

		DESCRIPTION	EOL
A	Z1 to Z8	Fire Detection Zones	CAP
B	S1, S2	Sounder Circuits	10K RES
C	FIRE RELAY	REL - Auxiliary Relay – Fire (Changeover)	NA
D	FAULT RELAY	REL - Auxiliary Relay – Fault (Normally closed)	NA
E	INPUT DE + EV	Programmable Remote Inputs	NA
F	RST	Remote Reset	NA
G	RM	Disablement on Zone Remote Output info	4k7 RES
H	AUX SUP	Auxiliary Supply Outputs - 28V DC @ 300 mA	NA



PANEL STATUS INDICATORS & CONTROLS

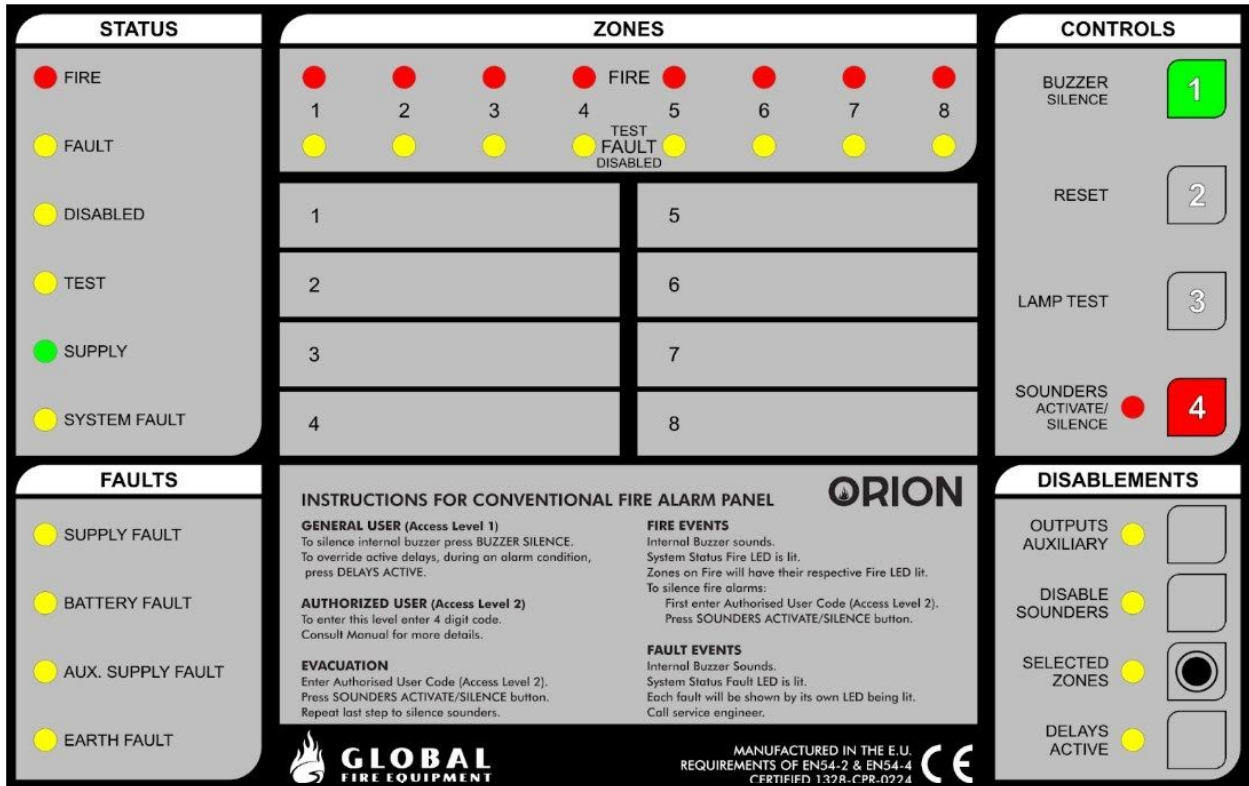

STATUS

FIRE – LED used to indicate any FIRE ALARM condition present on panel.

FAULT – LED used to indicate any Fault condition present on panel. If there is a communication Fault between ORION and an ORION MINI REP, a Sounder / Relay module or a GFE-ADLI V2 module, this LED will flash at a rate of once per second. If there is a Site Memory corruption, this LED will flash at a rate of once every 0.5 seconds.

DISABLED – Disabled Status LED used to indicate that the panel has features that have been disabled.

TEST – This LED is active whenever the panel is in TEST MODE, activated in Engineering Mode Access Level 3 only.

SUPPLY - Multi function indicator used to indicate the presence of supply. When in Access Level 1 this LED is permanently lit. If in Access Level 2 (USER CODE 2244) this LED will flash at a rate of once per second. If in Access Level 3 mode (ENGINEERING CODE 4321) this LED will flash faster at a rate of once every 0,5 seconds.

SYSTEM FAULT – This LED will be lit whenever there is a processor failure or corruption of the panel firmware.



FAULTS

SUPPLY FAULT – This LED will be ON whenever the Main Supply has been removed or has dropped below 20 Volts.

BATTERY FAULT – Indicates that there is low voltage level on the batteries or the battery charger circuit has failed.

AUX. SUPPLY FAULT – Indicates that the Auxiliary Supply has a fault.

EARTH FAULT – When this indicator is ON, there is leakage current flowing between the Earth connection/wiring and any other wire connected to the panel.

SOUNDER FAULT – If there is a conventional sounder output circuit fault, the general FAULT LED will be lit and the DISABLE SOUNDERS LED in the DISABLEMENTS section will be flashing.

RM FAULT – If there is a RM output circuit fault, the general FAULT LED will be lit and the DISABLE SELECTED ZONES LED in the DISABLEMENTS section will be flashing.

ZONES & INPUTS

Individual zone and monitored input indicators are provided for both FIRE/ALARM and FAULT conditions. If any zone is disabled, then its Fault LED will also be used to indicate the disablement of that particular zone/ input. The zone/ input Disabled LED will be ON along with the associated disabled status LED. Flashing Fault LED along with general Fault LED indicates a fault in that zone.

CONTROLS KEYS

These four keys can have more than one function. They are numbered to indicate that they are used to enter digits from 1 to 4 for code entry.

BUZZER SILENCE (1) – At Access Level 1 this button is used to silence the panel's internal buzzer. At Access Level 2 and 3 used to confirm/accept changes in programming. Buzzer must be always silenced before entering an access code to other levels.

RESET (2) – Press this button to reset the panel at Access Level 2 or 3.

NOTE: *≠H Y'Gci bXYfg'G%UbX'G&'UFY'UW'j YZF9G9H'Vi Htc'b'k J'' bchicdYfUH'i blj''h Y'Gci bXYfg'UFY gJ'YbWX'i gjbl' 'h Y'GCI B89FG'Vi Htc'b''*

LAMP TEST (3) – Press this button at Access Level 1 or 2 to test all LED indicators and the panel's internal buzzer. Release when test is finished. At Access Level 3, press this button to enter in “one man” test mode.

SOUNDERS (4) – Press once to activate/silence sounders in Level 2. If sounders are active, for example, during a FIRE condition or in the event of an Evacuation action, pressing this button will stop the sounders. Auxiliary Relays are not affected by this action. If a zone is programmed to be delayed, during a FIRE condition, pressing this button while the delay is running will stop the sounders from activating at the end of the delay time. This button is also used, in combination with the DISABLEMENTS buttons at access level 2 or 3, to select the desired configuration (Please refer to DISABLEMENT KEYS and PROGRAMMABLE OPTIONS section in this manual).

NOTE: *H Y'GCI B89FG'Vi Htc'b'Uggc'VUH'X'@8 'jg'C: : 'k \ Yb'h Y'Gci bXYfg'UFY'C: : zCB'k \ Yb'h Y'Gci bXYfg'UFY'CB'UbX': @ G<-B; 'k \ J'YU8 YUmija Yf'jg'fi bb]b[''*



DISABLEMENTS KEYS

Using these keys requires Access Level 2.

OUTPUTS AUXILIARY – Pressing this button will enable / disable the Auxiliary Relays. When the auxiliary Relays are disabled, the OUTPUTS AUXILIARY LED will be ON as well as the general DISABLED LED in the STATUS area.

DISABLE SOUNDERS – Pressing this button will enable / disable the conventional sounders circuits. When the conventional Sounders Circuits are disabled, the DISABLE SOUNDERS LED will be ON as well as the general DISABLED LED in the Status area.

SELECTED ZONES – Use this button to disable zones Z1 to Z8:

1. Press the SELECTED ZONES button in the disablements area of the control panel. The associated LED will turn ON.
2. Select the desired Zone to enable / disable by pressing the Red Switch (4) consecutively until the Yellow (FAULT) LED that corresponds to the desired zones is ON.
3. Confirm the selection by pressing Green (1) key. Upon confirmation the Red (FIRE) LED will be activated. Remove selection by pressing the Green key again. The corresponding LED will be switched OFF.
4. To exit the function press SELECTED ZONES button.

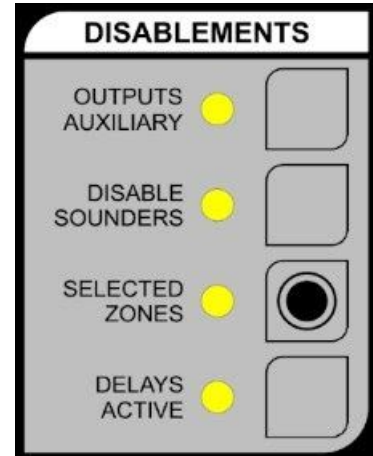

DELAYS ACTIVE – Pressing this button will enable the previously programmed delay (at Access Level 3). The corresponding LED will be ON as well as DISABLED LED in the STATUS area when delays are active. In access level 1, during a delay, started by an Alarm condition, pressing this button overrides the delay timer, activating the Fire Relay and the Sounders immediately.

NOTE: : cf'jbZfa UHjcb'fY[UFX]b['h YgdYVU'Z bWfjcbg'UggcVjUH'X'k Jh 'h Jg'Vi Htcbg'k \ Yb'jb'UWVYgg' 'Yj Y'' f9b[]bYYf]b['AcXYZzd'YUgYfYZf'lc'h YDFC; F5AA56 @ CDH-CBG'gYVf]cb'cb'h Jg'a Ubi U''

Disablements LEDs Status Table	
Disabled Circuit	Active Yellow LEDs
Zone 1 to Zone 8	DISABLED + Z1 to Z8
Relays	DISABLED + OUTPUTS AUXILIARY
Sounders	DISABLED + DISABLE SOUNDERS



KEYS FUNCTION TABLE

Buttons		<i>l gYf'</i> <i>@j Y' %</i>	<i>5 i h cf]nYX' l gYf''</i> <i>@j Y' &</i>	<i>9b[]bYf]b[' l gYf'</i> <i>@j Y' ''</i>
CONTROLS'				
BUZZER SILENCE	1 GREEN	<i>q' ^/oÁ</i> <i>~ ^/Á</i> <i>& á^Á</i>	<i>Ùq' } &^Á</i> <i>Ó' :: ^/Á</i>	<i>Ùq' } &^Á</i> <i>Ó' :: ^/Á</i>
RESET	2 --	<i>q' ^/oÁ</i> <i>~ ^/Á</i> <i>& á^Á</i>	<i>ËÁ</i>	<i>Ù^ ^oÁ</i> <i>Úeq' ^/Á</i>
LAMP TEST	3 --	<i>q' ^/oÁ</i> <i>~ ^/Á</i> <i>& á^Á</i>	<i>Šeq'] Á</i> <i>V^ oÁ</i>	<i>Šeq'] Á^ oÁ</i>
SOUNDERS ACTIVATE/ SILENCE	4 RED	<i>q' ^/oÁ</i> <i>~ ^/Á</i> <i>& á^Á</i>	<i>ËÁ</i>	<i>Ù^ ^oÁ</i> <i>Ù[~ } á^/ oÁ</i>
DISABLEMENTS				
OUTPUTS AUXILIARY		<i>ËÁ</i>	<i>Ò; aè ^ ËÁ aè ^ ÁÁ</i> <i>F YUng'</i>	<i>Ú! [*! aq' Ë[] - á{ Á</i> <i>7 c] bV] X YbVW'</i>
DISABLE SOUNDERS		<i>ËÁ</i>	<i>Ò; aè ^ ËÁ aè ^ ÁÁ</i> <i>Gci bXYfg'</i>	<i>Ú! [*! aq' Ë[] - á{ Á</i> <i>Bcb! UHW]b[' NcbYg''</i>
SELECTED ZONES		<i>ËÁ</i>	<i>Ú! [*! aq' Ë[] - á{ Á</i> <i>NcbYg 8]gUV' Ya Ybli</i>	<i>Ú! [*! aq' Ë[] - á{ ÁÁ</i> <i>8 YUm] X' NcbYg''</i>
DELAYS ACTIVE		<i>ËÁ</i>	<i>Ò; aè ^ ËÁ aè ^ ÁÁ</i> <i>8 YUng'</i>	<i>Ú! [*! aq' Ë[] - á{ Á</i> <i>8 YUm] H]a YfÁ</i>



Connection Diagrams

ZONES 1 to 8

Two, Four or Eight zones are available for detection device wiring. Each zone has capacity for up to 32 smoke/heat detectors and an unlimited number of manual call points. This may be restricted by local regulations.

An active end of line capacitor (10UF/50V bipolar) is supplied for each zone, as part of the monitoring circuit. This must be fitted to the last device of each Zone. If a detection zone is unused, the end of line module must be connected at the panel, if it's not fitted, a fault will be indicated for that zone.

A typical detector circuit wiring layout is shown below. Please consult the device manufacturer's instruction manual for detailed information.

If manual call points are wired on the same circuit as detectors, in order to comply with the requirements of BS5839 with respect to head removal monitoring, detector bases should have a Schottky diode fitted, which permits manual call points to continue to operate normally after a detector has been removed (see diagram). Manual call points should have a maximum internal resistance of (470-680) Ohms in Alarm.

The wiring for each detector zone should be terminated in the relevant terminal blocks at the control panel and the cable screens connected to earth.

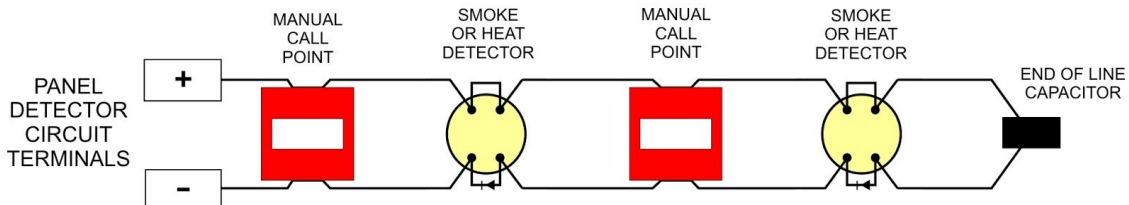

S1 & S2 MONITORED OUTPUTS

These output/sounder circuits have a combined maximum current output of 1 Amps (500mA per circuit).

Connected devices (sounders, beacons, bells, pyrotechnic actuators, solenoids, relays, etc.) must be polarized, non-polarized devices trigger a fault on the panel circuit. In order to mitigate this situation a polarization diode should be added when using bipolar devices. With solenoids, relays and bells a flyback diode should also be present.

An end of line resistor (10K Ohm) which is supplied with the panel, must be inserted in the last device for monitoring. If a sounder/output circuit is not used, the EOL resistor should be fitted in the respective control panel output.

The sounder circuits are protected against short circuits, the electronic fuse will reset when the short circuit is removed and the control panel is reset.

POLARIZED DEVICES

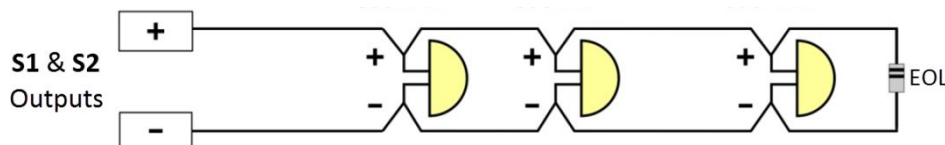



NON-POLARIZED DEVICES

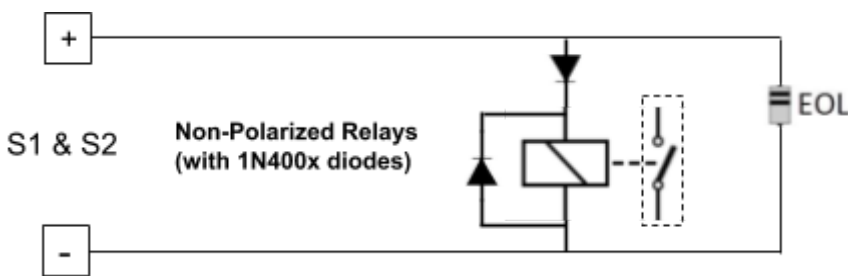
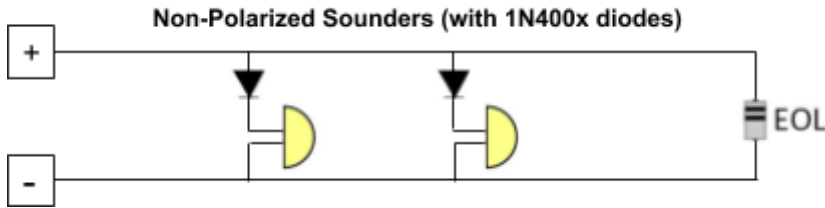

AUXILIARY INPUTS – Not Monitored

ORION remote activation inputs. All remote inputs are activated using a voltage free dry contact like a relay or manual ON-OFF switch between input and 'C' terminal.

INPUT DE – Allows switching between Day and Night operation from a remote location or using a timer clock. When 0V is applied via a voltage free contact, the DELAYS ACTIVE LED will turn ON indicating that the programmed delays are active (Day Operation). When the contact is open, the DELAYS ACTIVE LED will turn OFF and the programmed delays are ignored (Night Operation).



INPUT EV – Activates sounders immediately when 0V is applied via a voltage free contact. Sounders will continue to operate until the input is removed.

INPUT RST – Panel Reset: The closure of a contact at this input will cause the panel to reset. In order to re-apply a reset to the panel, contact has to be released and reapplied (Pulse action).

NOTE: *HA Y'k]f]b['Z:f 'YUM 'U I]]Ufm]bdi hig\ ci `X'VY'hfa]bUhX']b'h Yjf 'fYgdYW]j Y'hfa]bUg'UbX'h Y WUV'YgWYYbg'Vt:bbYW]X'tc 'YUfH "*

OUTPUTS – Monitored

AUXILIARY SUPPLY OUTPUT – 28V DC max 300 mA, short circuit protected, supervised. The output is protected against short circuit by an electronic fuse which resets when the fault is cleared and the panel is reset.

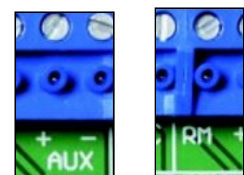

RM – Activate when a disablement zone is selected.



OUTPUTS – Non Monitored

FIRE Relay – Provide Fire signal to external devices.
Changeover contact rating: 30V DC / 2 A. Active until Reset.

FLT Relay – Provide normally closed Fault signal to external devices.
Relay contact rating: 30V DC / 2 A. max resistive. Also Active for microprocessor fault. Active until reset and all faults are cleared. Relay contact will open when any fault is present on the system.



NOTE: *H Yk Jf]b[Zf`YUW`ci hdi hgl ci`X`VY`hfa JbUHYX`]b`h Yjf`fYgdYWj Y`hfa JbUg`UbX`h YWUV`Y`gWYYbg`WtbbYWHX`tc`YUFA`"*

OPERATING AND PROGRAMMING THE PANEL

There are three access levels on the ORION:

LEVEL 1 – General User Controls

- Perform LEDs and Buzzer test
- Silence Internal buzzer
- Put the panel into Access Level 2 or 3 using required access codes.

LEVEL 2 – Authorized user controls (2244) or Access Key

This level allows the user to:

- Silence and reactivate S1 and S2 sounder outputs
- Reset after an Alarm or Fault
- Manually activate the sounders (Evacuate function)
- Silence Internal Buzzer
- Disable/Enable: Outputs; Zones & Sounders;
- Activate/deactivate Delays

NOTE: *K \ Yb`UbnincbYcf`Z bW]cb`]g`X]gUV`YXZH`Y8]gUV`YX`@8`cb`h`YGH5`HI`G`UFYUcZH`Y7`cb]fc``D`Ub`Y`X]gd`Unik`J`VY`]h]tc[`Yh`Yf`k`Jh`h`YWtffYgdcbX]b[`Z`bW]cb`cf`ncbYX]gUV`Ya`Ybh`@8`"8`]gUV`YX`ncbYg`k`J`Uj`Yh`Yjf`WtffYgdcbX]b[` :`5I`@#8`-G5`6`@8`@8`J`i`a`]bUHYX`"*

Level 2 Access is gained by entering the code **2244** using the numbered buttons. When in panel is in Level 2 the Green LED will flash with a frequency of 1 Hz.

Each successful button press is indicated by the illumination in sequence of the top screen Fault LEDs. If the code is not completed within 20 seconds of the last key press, the system reverts to Level 1.

NOTE: *Z`Ubn]i`JfYcf` :`Uf`hYj`Ybtg`Uj`YcWV`ffYX`h`YgY`a`i`gh`VY`UW`bck`YX[`YX`VmidfYgg]b[`h`Y6`i`nnYf`Gj`YbWV`Vi`Htc`b`tc`UW`bck`YX[`Y`YUW` :`Uf`hcf` :`JfY`Yj`Ybh`VYZ`fY`WtXY`Yb]fmik`J`VY`UWV`dhYX`"*

LEVEL 3 – Engineering Functions (4321)

It is accessed from Level 1 and allows:

- One Man Test
- Silence and reactivate S1 and S2 sounder outputs
- Panel Reset
- Manually activate the sounders (Evacuate function)
- Silence Internal Buzzer
- Program Coincidence
- Program Non-latching Zones
- Program Delayed Zones
- Program Delay Timer



NOTES:

% 7 \ Ub[Yg'a UXYUhih Jg`Yj Y`UZZYWhh YZUWcfmXYZUj `hgYHhjb[g`UbX`h YcdYfUjcb`cZH YgnghYa "Hl Ymi gl ci `X`cb`mVYa UXYVmiei UJZYX`dYfgcbbY`k \ c`UFYZ ``miUk UFYcZH Yjf`YZZWg"

& ZUbm: JfYcf': Uf `h`Yj Yblg \ Uj YcVWffYXZ`h YgYa i ghVYUW`bck `YX[YX`VmdfYgg]b[`h Y6 i nnYf` GJ`YbW`Vi Htc b`tc `UW`bck `YX[Y`YUM `ZUj `hUbX': JfY`Yj YbhVYZ`fYV`eXY`YbIfmik J`VYUWVdhX"

' £ K \ Yb `Jb`5 WYgg`@j Y" `Zh YcVWffYbW`cZUbm: JfYcf': Uf `hV`bX]hcb`h YgnghYa `k J`Uf Hca UjWU`mi Yl JhZca `@j Y" `UbX`fYj Yfhlc `@j Y`&"

To enter Engineering Mode (Access Level 3) enter the code 4321, using the numbered keys (from 1 to 4), which are available on the top right-hand side of the control panel display. Each successful button press is indicated by the illumination in sequence of the Fault LEDs for zones 3, 4, 5 and 6. If the code is not completed within 20 seconds of the last key press, the system reverts to Level 1.

Once this mode is entered the Green LED (SUPPLY) will flash once every 0,5 seconds. To exit this mode at any time, press the RESET button. The panel will revert to Access Level 1. Total removal of power during the programming phase could cause changes not to be saved.

COMMISSIONING

The ORION is supplied ready to operate as a standard conventional Fire Alarm control panel. Additional function programming is described in the next section.

The default settings for the ORION are as follows:

- All zones Latching
- All Timers OFF
- No Zone Coincidence
- Authorized User Access Code (Level 2): 2244
- Alternatively, access to Level 2 can be entered using the Physical Access Key provided
- Engineering Access Code (Level 3): 4321.

PREPARATION

- 1°. Check detector cables and ensure all field connections are made, ensure that all EOL devices are fitted to the last detector, call point or sounder of each circuit. EOL Capacitors should be fitted to zones or remote monitored inputs. EOL Resistors should be applied to sounder/output circuits.
- 2°. Connect detector and sounder lines or terminate with EOL.
- 3°. Remove the mains fuse.
- 4°. Connect mains supply according to local mains voltage. Ensure good earth connection.
- 5°. Fit batteries (Do not connect).
- 6°. Insert mains fuse and connect batteries - Observe correct polarity.

COMMISSIONING

- 1°. If all is normal only the Green "supply" LED should be illuminated.
- 2°. If any Faults are indicated, they should be corrected before proceeding.
- 3°. Initiate lamp test and check LEDs and internal buzzer operation.
- 4°. Test each key for correct functioning.
- 5°. Test all detectors, manual call points, sounders, relays etc. for proper operation.



TESTING ZONES – Z1 to Z8

- 1°. Set zones to Test mode with level 3 access.
- 2°. Press LAMP TEST key.
- 3°. Activate device according to manufacturer specification.
- 4°. Wait until the response indicator on the device indicates Red.
- 5°. Reset initiating devices or until detectors are normal.
- 6°. Automatic reset after (10 sec).

NOTE: 5 Zmf hYgl]b[]g`Wta d`YhXZVYgi fY'lc fYfi fb`h YWb]fc`dUbY`lc`bcfa U`cdYfU]b[`a cXY"
DfYgg]b[`h YF9G9H`Vi htc b`k]`9L`#H9GH`a cXY"

TESTING – S1 and S2 Output Circuits

- 1°. Initiate sounder test by entering Access Level 2 and pressing SOUNDERS ACTIVATE/SILENCE.
- 2°. Press again to Stop.

TESTING – FIRE and FLT Relays

With the system in normal operating mode induce an Alarm and a Fault to confirm proper operation of relays and external devices at the end of any programmed delay.

PROGRAMMABLE OPTIONS

The ORION has a number of programmable options to help the engineer customize the system to meet the customer's requirements. To access these options it is necessary to enter Access Level 3.

ONE MAN TEST

After entering Engineering Mode (Access Level 3) press the LAMP TEST button. Release button and the TEST LED will be on along with the fault LED for all zones that are available for testing indicating that the panel is in TEST mode.

Zones that are in Fault or are Disabled will not have their LED illuminated.

Test the zones accordingly with installation requirements. At each zone activation, the corresponding zone FIRE LED will light up for 5 seconds.

Zones will automatically reset after 10 seconds. Internal Buzzer and SOUNDERS will operate for 1 second.

To end TEST mode press the LAMP TEST button.

To exit Engineering Mode (Access Level 3), press the RESET button.

COINCIDENCE

1. After accessing Level 3, press the **OUTPUTS AUXILIARY** button in the disablements area of the control panel. The associated LED will turn ON.
2. Select the pair of zones desired to work in Coincidence by pressing the Red Switch (4) consecutively until the Yellow (FAULT) LED that corresponds to the desired zones pair is ON (Please refer to the table below for additional details).
3. Confirm the selection by pressing GREEN (1) key. Upon confirmation the Red (FIRE) LED will be activated. Remove selection by pressing the GREEN key again. The corresponding LED will be switched OFF.
4. To exit the function press **OUTPUTS AUXILIARY** button.

NOTES:

- 1) Coincidence only has an effect on the FIRE Relay.
- 2) If one of the programmed Paired Zones is disabled, the Fire Relay will not activate in the event of a Fire in the other Zone of the pair.
- 3) Non-latching Zones should not be set to Coincidence.



Coincidence Configuration Table									
Active RED LEDs during setup	ALL LEDS OFF	Z1	Z2	Z3	Z4	Z5	Z6	Z7	Z8
Pair of Zones with Coincidence	No Coincidence Programmed	Z1+Z2	Z3+Z4	Z5+Z6	Z7+Z8	-	-	-	-

NON-LATCHING ZONES

1. After accessing Level 3, press the **DISABLE SOUNDERS** button in the disablements area of the control panel. The associated LED will turn ON.
2. Select the desired Zone to work as non-latching by pressing the Red Switch (4) consecutively until the Yellow (FAULT) LED that corresponds to the desired zones is ON.
3. Confirm the selection by pressing GREEN (1) key. Upon confirmation the Red (FIRE) LED will be activated. Remove selection by pressing the GREEN key again. The corresponding LED will be switched OFF.
4. To exit the function press **DISABLE SOUNDERS** button.

DELAYED ZONES

1. After accessing Level 3, press the **SELECTED ZONES** button in the disablements area of the control panel. The associated LED will turn ON.
2. Select the desired zone to have a delayed operation by pressing the Red Switch (4) consecutively until the Yellow (FAULT) LED that corresponds to the desired zone is ON.
3. Confirm the selection by pressing GREEN (1) key. Upon confirmation the Red (FIRE) LED will be activated. Remove selection by pressing the GREEN key again. The corresponding LED will be switched OFF.
4. To exit the function press **SELECTED ZONES** button.

DELAY TIMER

1. After accessing Level 3, press the **DELAYS ACTIVE** button in the disablements area of the control panel. The associated LED will turn ON.
2. Select the desired Delay Time by pressing the Red Switch (4) consecutively until the Yellow (FAULT) LED that corresponds to the desired zone is ON (Please refer to the table below for additional details).
3. Confirm the selection by pressing GREEN (1) key. Upon confirmation the Red (FIRE) LED will be activated. Remove selection by pressing the GREEN key again. The corresponding LED will be switched OFF.
4. To exit the function press **DELAYS ACTIVE** button.

Delay Configuration Table									
Active RED LEDs during setup	ALL LEDS OFF	Z1	Z2	Z3	Z4	Z5	Z6	Z7	Z8
Corresponding Delay in minutes	0	1	2	3	4	5	6	7	8

NOTE: *Non-latching zones configuration instructions (scrambled text)*

NOTE: *Delayed zones configuration instructions (scrambled text)*

NOTE: *Delay timer configuration instructions (scrambled text)*



TROUBLESHOOTING - FAULT INDICATIONS

NOTE: *Hfci VYg\ cchjb[`cZUmZU `hcb`h YdUbY`g\ ci `X`cb`mVY`WUffJYX`ci hVmiei UJZYX`hVW bJWUbg"*

General Fault - The General fault LED is illuminated whenever there is a fault on the system. It is always lit along with at least one other fault indicator which gives more detail relating to the fault. The General Fault LED is flashing at a rate of once per second indicates that the communication between the ORION panel and one or more of the modules / repeaters has been lost or is corrupted.

Zone Fault - This type of fault will indicate that there is either a short or open circuit condition on the zone circuit. Revise wiring.

Sounder Fault - This type of fault indicates that there is either a short or open circuit condition on one of the conventional sounder circuits. Revise wiring.

Supply Fault - Associated with a low voltage (below 20 V) present at the input of the power supply or the removal of the main power supply. Measure voltage levels and verify electrical mains fuse.

Battery Fault - This fault is present when there is a low voltage below 20V DC at the battery terminals or if there is a battery charger problem. Charger problems can be caused by panel's hardware failure or batteries that have not been connected in the specified manner as indicated in this manual, on the installation section. Verify if batteries are properly connected. Measure the voltage at the battery terminals. If it is below 21V DC replace batteries. Remember to verify also the main electrical fuse.

NOTE: **Don't short circuit battery terminals in order to verify battery charge. Only use batteries which are batteries which are VLRA LEAD ACID 12V DC.**

Earth Fault - This FAULT will indicate that there is some level of current leakage between any of the wire conductors and the EARTH connections. For additional info please check website FAQ Fault Finding section.

System Fault - This FAULT indicates that there is a fault at the main processor level. In this particular fault, the panel's main board needs to be replaced or repaired.

STANDBY BATTERY CALCULATION

Battery capacity should be between 2 x 2.4 Ah 12V DC and 2 x 7 Ah 12V DC.

The battery Ah required for a given installation is calculated from the following formula:

$$\left(\begin{array}{l} \text{Quiescent current in} \\ \text{mA of the panel with} \\ \text{everything} \\ \text{connected} \end{array} \times \begin{array}{l} \text{Standby time} \\ \text{required in} \\ \text{hours} \\ \text{divided by} \\ 1000 \end{array} \right) + \left(\begin{array}{l} \text{Alarm} \\ \text{current in} \\ \text{Amps} \\ \text{(sounder} \\ \text{load)} \end{array} \times \begin{array}{l} \text{Alarm} \\ \text{time in} \\ \text{hours} \end{array} \right) + 20\%$$

Round the result to the next available battery size. Quiescent current of the panel with everything is found by adding the standby current of all connected devices to the standby current of the panel (38 mA). Consult the manual for the individual devices to confirm the standby current.



ANCILLARY DEVICES

Repeater Interface Connection

The interface board used to establish communication between the ORION and its associated repeater(s) should be linked to the connector labelled **DATA**, which is situated on the underside of the panel's main board. The interface should be fixed to the base of the back box as shown before. The panel's main board and interface are connected using the 5-way flat cable provided. The cable is fitted with 2 polarized connectors of the Molex type.

For details about connection, please refer to the repeater installation manual.

ADLI V2 Connection

ADLI V2 allows the connection to a GFE Addressable panel, should be linked to the molex connector labelled **DATA**, this connector is located underside of the panels main board..

Expansion Modules Connection

The ORION and its expansion modules should be linked to the molex labelled **MPX**, this connector is on the underside of the panel's PCB board. The following modules can be directly connected to the main panel or through an interface (RS232, RS485, FO) if installed far from the main panel.

- **GFE-MPX-REL V2** for Relay activation extension, should be linked to the connector labelled MPX.
- **GFE-MPX-SNDR V2** for Sounder activations (Z1, Z2, Z3F, etc), should be linked to the connector labelled MPX.

GFE-MPX-SNDR V2 and GFE-MPX-REL V2 outputs will activate upon the ORION panel actions shown in the table below.

ORION	Z1 ALARM	Z2 ALARM	Z3 ALARM	Z4 ALARM	Z5 ALARM	Z6 ALARM	Z7 ALARM	Z8 ALARM
GFE-MPX-SNDR V2 / GFE-MPX-REL V2 OUTPUTS	S1 / REL1	S2 / REL2	S3 / REL3	S4 / REL4	S5 / REL5	S6 / REL6	S7 / REL7	S8 / REL8

For details about connection, please refer to specific module installation manual or contact authorized GFE distributor.



Connection diagram of ancillary Modules (only compatible with V2 versions)

5-way flat cable from MPX, 5-way connector on underside of ORION main board to MPX 5-way connection on GFE-MPX-SNDR-V2 or GFE-MPX-REL-V2 board

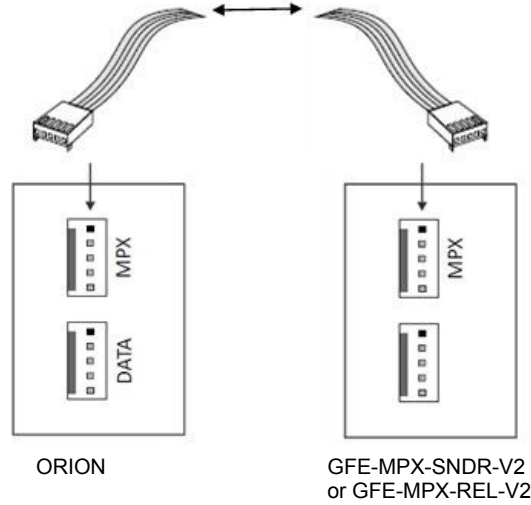

Connection to “ORION Mini Repeater V2” or ADLI V2 Module

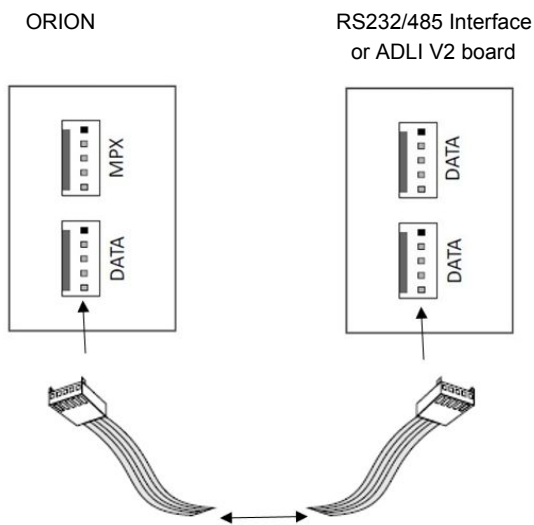

5-way flat cable from DATA 5-way connector on underside of ORION main boards to DATA 5-way connector on RS232/485 or ADLI V2 board



TECHNICAL SPECIFICATIONS	
PRIMARY SUPPLY VOLTAGE - IN	230 +10% -15% V AC
PRIMARY SUPPLY VOLTAGE- OUT	28.5V DC nominal
PRIMARY SUPPLY CURRENT-OUT	1.7 A @ 28.5V DC nominal (max.)
SECONDARY SUPPLY VOLTAGE	21.0 min. - 27.2 max. V DC - BAT charger o/p 28V DC
SECONDARY SUPPLY CURRENT OUTPUT	1.85 Amp maximum @ 20°C
INTERNAL BATTERY CAPACITY - MAXIMUM	2 x 12V x 7Ah Sealed VRLA Lead Acid Batteries
MAINS FUSE	4 A -250 V Slow Blow - 20 mm
BATTERY FUSE	1.85 Amp - Resettable
NUMBER OF DETECTION ZONES	2 / 4 / 8
ZONE CURRENT - QUIESCENT / ALARM	10 mA / 60 mA maximum
MAX. CABLE RESISTANCE / CAPACITANCE	40 Ohms / 0.470 uF
END OF LINE MONITORING	Active EOL - 10uF/50V Bipolar Capacitor
BS5839 DETECTOR REMOVAL COMPLIANT	YES provided diodes are fitted to detector base
DEVICES PER ZONE	32 maximum - EN54 pt.2
ALARM RESISTANCE VALUE: INPUTS	270 - 1000 Ohms
MAXIMUM CURRENT: OUTPUTS	1A maximum current drive for both S1 & S2 circuits (500mA each)
VOLTAGE OUTPUT	27.5VDC nominal
END OF LINE RESISTOR: S1 & S2	S1 & S2: 10K Ohms - 1/4 Watt
AUXILIARY RELAY OUTPUT	1 Fire (COM-NC-NO) - 1 Fault (COM-NC) non-supervised
RELAY CONTACT RATING	30V DC - 2 Amp resistive loads
FULLY MONITORED INPUTS	Remote Activation, Remote Abort, Solenoid Status, Flow/Pressure Switch Status
EVACUATION AND RESET	Non-Latching - Voltage free contact
MAXIMUM HUMIDITY	95% RH Non-Condensing
PROTECTION RATING	IP30
OPERATING TEMPERATURE	-10°C to 50°C
WEIGHT	1.7 Kg - 7 Kg (inc. 2 x 7 AH 12 V bat.)
DIMENSIONS	273 (L) x 107 (W) x 404 (H) mm
COLOUR	White or Red

GLOBAL FIRE EQUIPMENT S.A.

Sítio dos Barrabés, Armazém Nave Y, Caixa Postal 908-Z, 8150-016 São Brás de Alportel - PORTUGAL
Tel: +351 289 896 560 • Sales: sales@globalfire.pt • Technical Support: techs@globalfire.pt • www.globalfire.pt